

# bizhub PRO 1200 / 1051

## Specifications

Model name	bizhub PRO 1200 / 1051		
Type	Console		
Resolution	1200dpi x 1200dpi		
Memory	768MB (RAM) + 160GB (HDD) (HDD: 40GB raw, 120GB Box storage)		
Gradation	256 levels		
Type of originals	Sheet, book, 3D objects		
Maximum document size	A3 Wide		
Copy size	Paper size	A3 Wide, A3, B4, A4/A45*, B5/B55*, A5, postcard (182x139mm - 324x463mm)	
	Non-effective image area	Top edge: less than 3.0mm, Bottom edge: less than 2.0mm Right/Left edge: less than 2.0mm	
1st copy output time	1200: 2.8sec., 1051: 3.0sec. (with A4 platen, straight delivery)		
Warm-up time	Less than 480sec. at room temperature (20C) and the rated voltage		
Continuous copy speed	1200: 120 sheets/min, 1051: 105 sheets/min		
Magnification	Fixed ratio	Direct: 1:1 ± 0.5% or less	
	Enlargement	1:1.189/1.414/2.000	
		Reduction	1:0.840/0.707/0.500
	User set ratio	3 types can be set	
	Zoom	25% to 400%, adjustable in 1% increments	
Vertical/horizontal independent zoom	25% to 400%, adjustable in 1% increments		
Paper supply	1,500 pages x 2 (80g/m <sup>2</sup> )		
Paper weight	Plain / recycled paper: 60-91g/m <sup>2</sup>		
	Thick paper: 92-350g/m <sup>2</sup> (301-350g/m <sup>2</sup> can only be fed from PF-702 / PF-703 middle tray)		
	Thin paper: 40-49g/m <sup>2</sup> (there are restrictions on papers types that may be used)		
Multiple	1-9999 sheets		
Double-sided copying	Stackless ADU standard		
	Paper size: Max: 324mm x 463mm; Min: 95mm x 139mm (when optional postcard adapter is used)		
	Paper weight 40-244g/m <sup>2</sup>		
Power	230V, 25A (50Hz)		
Power consumption	Max. 5, 25A		
	(Main unit + PF-703 / PF-703 + RU-506 + FA-501 + FD-503 + SD-506 + FS-521)		
Dimensions (W x D x H)	990 x 780 x 1,190mm (with DF / excluding operation panel)		
Weight	375kg		

\*S: Short edge feed

## Scanner Function (standard for bizhub PRO 1200 / 1051)

Type	B/W
Speed	105opm
Max. original size	A3 (297 x 420mm)
Scanner file format	TIFF, PDF / Encrypted PDF / XPS
Scanner resolution	200 x 200dpi / 300 x 300dpi / 400 x 400dpi / 600 x 600dpi
Interface	Ethernet (1000Base-T, 100Base-TX, 10Base-T)

## Network printer function (standard)

Type	Embedded type	
CPU	Pentium M 2.0GHz, Memory Access Speed 533MHz	
Memory	2GB (standard)	
Speed	1200: 120ppm, 1051: 105ppm	
Resolution	1200 x 1200dpi	
Printer languages	PCL 5e / XL (PCL 6) / PostScript3 (PS 3017) / PDF Direct Print (PDF ver. 1.6) / TIFF Direct Print / PPML	
Network protocol	TCP/IP, IPX/SPX, NetBEUI, EtherTalk, IPP	
Operating system	PCL	Windows 2000/XP/2003server, Windows Vista, Windows XP/2003server x64, Windows Vista x64
	PS PPD/ PS Plug-in	Windows 2000/XP/2003server, Windows Vista, Windows XP/2003server x64, Windows Vista x64, Mac OS X 10.3, Mac OS X 10.4 (PPC/Intel), Mac OS X 10.5 (PPC/Intel)
Fonts	PCL	European Font (Agfa Micro Type 80 types, Symbolset 36 kinds)
	PS	European Font Adobe 136 types
Interface	Ethernet (1000Base-T, 100Base-TX, 10Base-T), USB 2.0	

## System Options

PF-702 Paper Feed Unit	3 x 2,000 sheet paper feed unit, A5-A3+, 40-300g/m <sup>2</sup> (all trays), 40-350g/m <sup>2</sup> (middle tray), all trays universal
PF-703 Paper Feed Unit	2 x 1,850 + 1,300 sheet paper feed
FS-521 Staple Finisher	Finisher with 2 trays, max. 3,000 sheets main tray, 200 sheets sub tray, A5-A3+, 50-244g/m <sup>2</sup> (40-350g/m <sup>2</sup> sub tray), 100 sheet / multi-position stapling, staple cut function
SD-506 Saddle Stitch Unit	Saddle stitcher with fold and trim functions A4-A3; stitching / trimming 50 sheets, 50-244g/m <sup>2</sup> ; center fold: 50-244g/m <sup>2</sup> ; 3-fold: 50-91g/m <sup>2</sup> , max. 5 sheet folding; exit tray: max. 200 sheets, 40-350g/m <sup>2</sup>
FD-503 Multi-fold Punch Unit	2 x 500 sheet multi-fold post inserter, punch unit; main tray: A5-A3+, 40-350g/m <sup>2</sup> , max. 2,500 sheets; sub tray: A5-A3+, 40-350g/m <sup>2</sup> , 200 sheets; 2/4 hole punch, A5-A3, 50-216g/m <sup>2</sup> ; booklet / letter (in/out) / Z-fold, double-parallel and gate-fold, A4-A3, 50-130g/m <sup>2</sup> (50-91g/m <sup>2</sup> double-parallel and gate-fold); max. 30 sheets folding, post inserter for A5-A3+, 50-300g/m <sup>2</sup> ; 2 trays x 500 sheets
FA-501 PI-PFU Unit	2 x 1,850 + 1,300 sheet inserter
LS-505 Large Capacity Unit	5,000 sheet stacker (main tray), 200 sheet (sub tray), A5-A3+, 50-244g/m <sup>2</sup> (40-350g/m <sup>2</sup> sub tray)
PB-502/503 Perfect Binder Unit	Perfect binder - bound pages: A5-A4 (max. 307mm x 221mm), 64-91g/m <sup>2</sup> (PB-502), 64-105g/m <sup>2</sup> (PB-503), max. approx. 300 sheets / 600 pages (30mm thick or less) / min. approx 10 sheets; cover sheet: max. 307mm x 472mm, 82-161g/m <sup>2</sup> (PB-502), 82-216g/m <sup>2</sup> (PB-503), 1000 sheets (82g/m <sup>2</sup> )
GP-501 Multi-hole Punch Unit*	Multi hole punch unit for ring book binder, 75-216g/m <sup>2</sup> , 297mm x 210mm

## System Overview

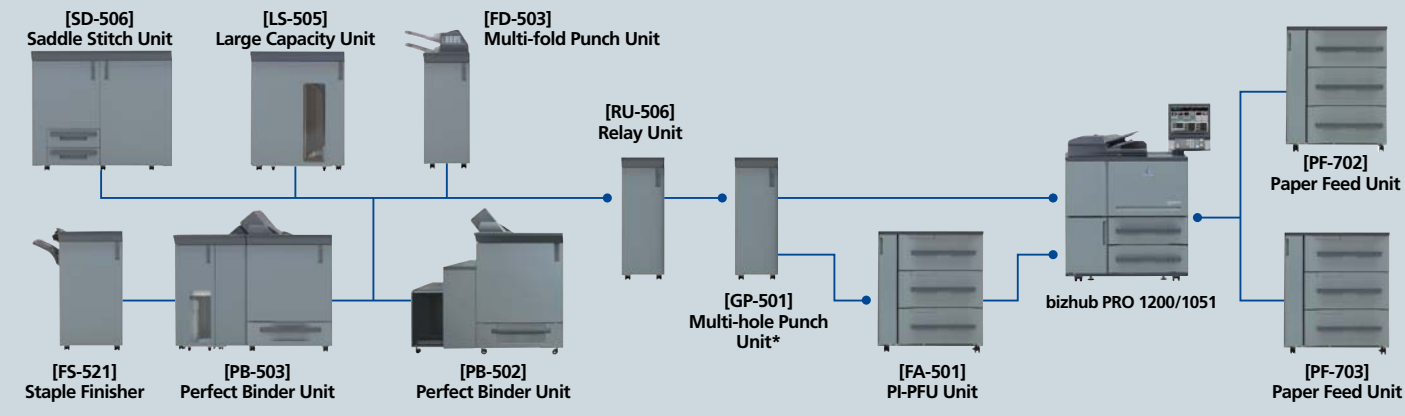

\*The GP-501 Multi-hole Punch unit is not available in all countries. Please ask a sales person for details.

## Product appearance, configuration and/or specifications are subject to change without notice.

KONICA MINOLTA, the KONICA MINOLTA logo and symbol mark, and "The essentials of imaging" are registered trademarks or trademarks of KONICA MINOLTA HOLDINGS, INC. bizhub, bizhub PRO, bizhub PRESS, Magicolor, PagePro, PageScope, Simitri, Simitri HD, Simitri HD+, Simitri with Biomass, Emperon, S.E.A.D., S.E.A.D.II, Printgroove and Konica Minolta Optimised Print Services and their respective logos are registered trademarks or trademarks of KONICA MINOLTA BUSINESS TECHNOLOGIES, INC.

All other brands and product names are registered trademarks or trademarks of their respective companies or organisations.



## Ecology & Environment

KONICA MINOLTA products are designed with the environment in mind.

- Energy Star
- RoHS Compliance
- WEEE Compliance
- Eco-friendly Toners
- Production at ISO Certified Factories



From consulting, system design, to operations, Konica Minolta offers total support to optimise your office output environment.

<http://www.biz.konicaminolta.com/services/ops>

## Requirements for safe use

- Please read and follow the instruction manual to ensure safe operation.
- Only operate using appropriate power supply and voltage.
- Connecting the earth wire to an inappropriate place may cause explosion or electric shock. Please connect accordingly (Taiwan and the Philippines only).

## KONICA MINOLTA BUSINESS TECHNOLOGIES, INC.

1-6-1 Marunouchi Chiyoda-ku, Tokyo, Japan  
<http://www.biz.konicaminolta.com>

9251-3185-41 Printed in Japan



KONICA MINOLTA

# bizhub PRO 1200 / 1051



*Empowered Production Printing with High-Speed, High-Quality Performance*



Giving Shape to Ideas

# The evolution of on-demand monochrome production printing, delivering total performance: confident reliability, efficient productivity and superb output quality

In the production printing world, the ability to handle on-demand jobs is fast becoming essential to survival. With customers making increasing demands on your small-lot capabilities, success depends on delivering a wider range of high quality services while keeping costs, turnaround times and downtime to a minimum. To meet the ever-growing needs of production printing for high-level reliability, efficiency and flexibility, Konica Minolta introduces the new bizhub PRO 1200/1051. Raising the bar even higher on productivity, quality and dependability, this new lineup empowers your production print facilities to provide better value for your customers and maximise your profitability.

for Heavy Production Printing

## **bizhub PRO 1200**

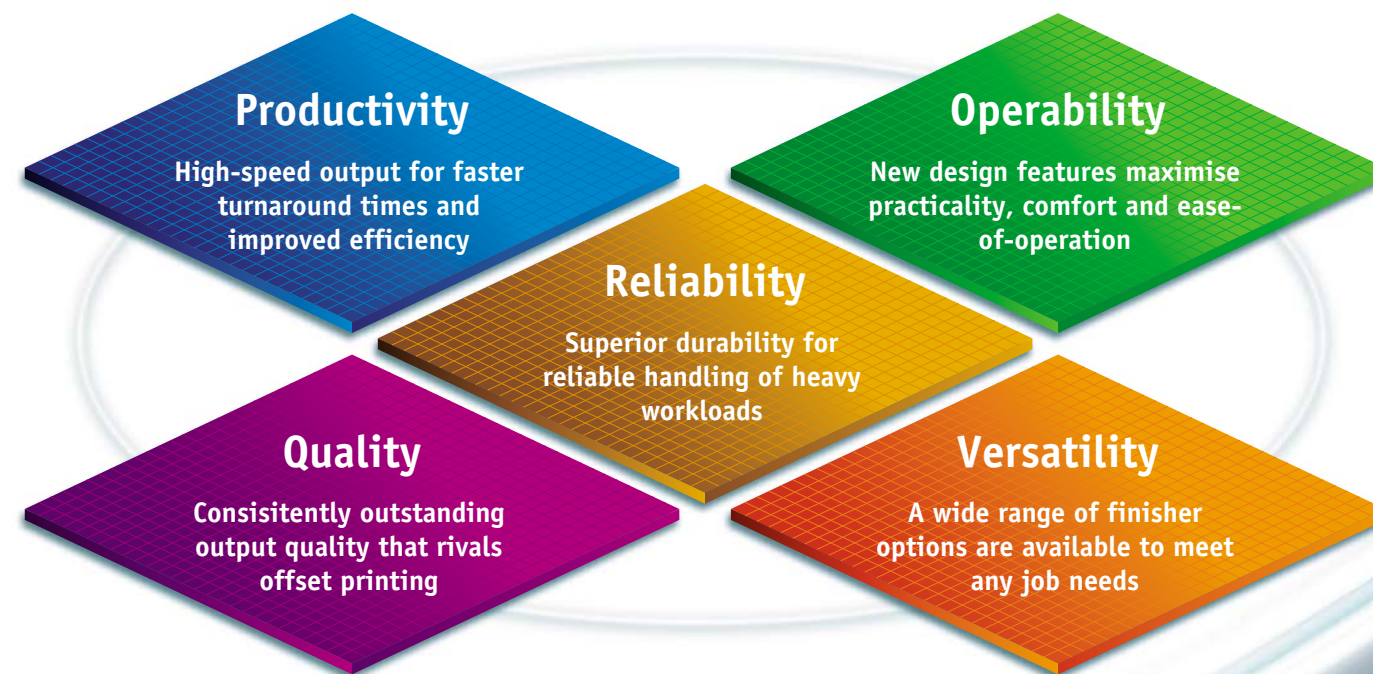

for Light Production Printing

## **bizhub PRO 1051**



# On-demand Production Printing Solutions

## Solution 01 Cost Performance

By providing more cost-efficient performance and greater reliability, the bizhub PRO is the more economical choice

### ■ Total cost reduction

Compared alongside competing production print machines, bizhub PRO 1200/1051 achieves remarkably cost-efficient performance. By using a more durable construction for greater reliability and less downtime, running costs are significantly lowered. Even as the cost-effective choice, however, bizhub PRO 1200/1051 is also an extremely high-performance machine.

### ■ Wide range of small-lot printing choices

Because it eliminates the need for photographic plates or films that offset printing machines must use, the bizhub PRO 1200/1051 is ideal for rapid handling of multiple small-lot on-demand print jobs. Users can print just the necessary amount right when it's needed, eliminating the need to keep additional prints in stock and reducing overall costs.

## Solution 02 In-house Capabilities

Offering a broad range of paper-handling and finishing capabilities enables more jobs to be done in-house at lower cost

### Wider range of paper weight compatibility, up to 350g/m<sup>2</sup>

The bizhub PRO 1200/1051 can handle paper types between 40g/m<sup>2</sup> up to 350g/m<sup>2</sup> as well as coated paper, pre-printed paper and other types. This allows a greater range of job types to be taken on, increasing the total number of orders coming in.

### Available finishing options enable advanced functions to be performed quickly and effectively

#### ■ Saddle Stitcher (SD-506)

This unit can staple together up to 50 sheets at once, for booklets of up to 200 pages. A fore-edge cutting function is also available for cleaner edges suitable for magazines or manuals.

#### ■ Perfect Binder (PB-502, PB-503)

Up to 300 sheets (or a maximum total thickness of 30mm) can be perfect bound to create professional-looking bound documents of up to 600 pages.

#### ■ Stapler (FS-521)

Up to 100 pages can be stapled at a time, allowing booklets to be produced quickly and efficiently. The needle-cut function clears away the ends of the staples for cleaner, more attractive finished documents.

#### ■ Multi-fold Unit (FD-503)

6 different folding patterns, including centre folding, 3-folding and gate-folding, can be assigned to individual pages within a particular job. This unit can also perform hole punching and sheet insertion.

### By selecting the finishing functions your workplace needs, an optimised workflow can be arranged, such as these suggestions:

#### System 1 For high-volume, high speed commercial printing

With a 13,000\*-sheet paper supply and a 10,000\*-sheet output holding capacity, this arrangement enables fast turnaround times. This arrangement is recommended for straightforward large-volume printing jobs, with jobs requiring finishing being performed on a separate system. \*80g/m<sup>2</sup> paper



#### System 2 Versatile finishing for easy small-lot job completion

With an 8,000\*-sheet paper supply, this arrangement provides a versatile array of in-line finishing functions, including hole-punching, center-stapling, and perfect binding. The versatility of this arrangement makes it ideal for handling jobs requiring finishing. \*80g/m<sup>2</sup> paper

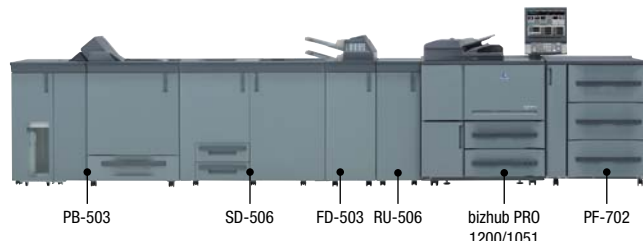

bizhub PRO 1200/1051 offers far more than printing – it creates new possibilities for production print services to increase business by offering greater value

## Solution 03 Variable Printing

Taking full advantage of the flexibility of on-demand printing, this feature delivers results with significant added value

### Variable printing\* makes each output sheet uniquely customised. Used in combination with offset printing, this creates a powerful tool for meeting one-to-one market needs

\*Requires additional software

#### ■ Leaflet / Flier

Information such as store names and addresses or special sales information can be applied to leaflets and fliers pre-printed in colour for ready distribution.



#### ■ Direct Mail

Postcards pre-printed in colour can have individual recipient data, such as names and addresses, added to them.



## Solution 04 Environmental Consideration

By adopting an ecologically sound design, resource and energy consumption are reduced

#### ■ Energy Star

The bizhub PRO 1200/1051 conforms to the guidelines of the International Energy Star Program for reduced energy consumption and improved efficiency.



#### ■ RoHS compliance

In compliance with the EU's RoHS (Reduction of Hazardous Substances) regulations, Konica Minolta will eliminate the use of harmful materials, including lead, mercury, cadmium, hexavalent chromium, PBB and PBDE from the production of all electronic components.



## Solution 05 Security

To ensure customer data is kept safe, bizhub PRO 1200/1051 offers an array of robust security features

### Advanced Security Mode provides enhanced protection of data

#### ■ Data protection and removal

After a job is completed, all data in HDD storage and active memory, whether compressed or not, is overwritten with random data before being used for the next job.

#### ■ Security Log

This function produces a record of all past security activities for later review. Date and time of operations, type of operation, and the information accessed are all recorded, making it possible to detect unauthorised access attempts during later analysis.

#### ■ Strengthened password protection

#### ■ User authentication

#### ■ HDD lock

#### ■ Secure print

#### ■ Management mode



The solutions of **i**

Document Solutions For The Way You Work

Konica Minolta's Solutions of **i** include our extensive lineup of MFP's, printers and software applications designed for you, the individual.

<http://www.solutions-of-i.com>

## High Productivity & High Reliability

The advanced paper handling capability of bizhub PRO 1200/1051 provides an invaluable productivity edge for any production printing needs



## Quick response and high-speed output

### Higher printing speeds

The bizhub PRO 1200 is capable of producing single- or double-sided output at a rate of 120ppm\* (A4 horizontal), with a warm-up time of under 8 minutes and a first-copy output time of only 2.8 seconds. To further reduce downtime, paper and toner can be replaced while the bizhub PRO 1200/1051 is in operation, without needing to stop.

\*The bizhub PRO 1051 prints at 105ppm (A4, horizontal), with FCOT of 3.0 seconds

### Faster data processing

The built-in print controller uses a Linux operating system for robust, reliable performance. This allows accelerated data processing and variable printing, for maximum productivity. This system also boasts multi-OS compatibility, allowing easy integration with pre-existing networks.



### Large capacity toner bottle

This reduces the number of times the toner needs to be replaced.

## High-productivity paper handling for a range of needs

### Improved paper compatibility

With the improved paper feed and transfer processes, a greater range of paper types can now be used, including types which previously had been difficult to handle, such as coated and pre-printed paper. This allows users to accept a greater range of job types and offer customers more output choices.



### All trays handle A3 Wide size

All trays on the bizhub PRO 1200/1051 can handle A3 Wide sheets of up to 324mm x 463mm maximum size, with a printable area of 314mm x 463mm. Sheets as small as postcard size may also be handled within the main body (when the optional postcard kit is attached to the main body tray).

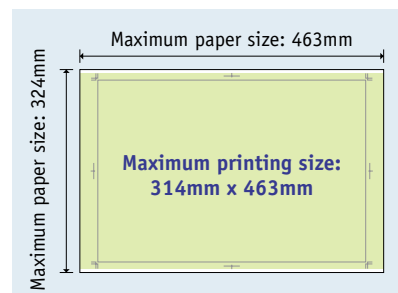

### Compatible with sheets up to 350g/m<sup>2</sup>

The main body's paper trays handle weights of 40 to 244g/m<sup>2</sup>, while the optional Paper feed Unit handles up to 350g/m<sup>2</sup>. Paper between 40 and 216g/m<sup>2</sup> can be printed at 100% productivity. Double sided printing is possible for paper up to 244g/m<sup>2</sup>, as well as for postcards\*.

\*When the optional postcard kit is attached to the main body tray.



## Smooth, efficient paper handling

### Maximum storage of 14,000 sheets

With two 1,500-sheet standard paper trays and the optional PF-702 and PF-703 Paper Feed Unit connected in tandem, the bizhub PRO 1200/1051 has a maximum capacity of 14,000\* sheets. Because paper trays can be refilled without interrupting output, large-volume jobs can be processed without downtime.

\*80g/m<sup>2</sup>

### 5,000-sheet stacking capability with convenient dolly

The optional LS-505 Stacker with dolly can handle up to 5,000 sheets\*. Using two stackers in tandem, up to 10,000 sheets are always at the ready. After paper is delivered from the stacker, it can be carried to the next process as-is with the dolly. This paper delivery capacity significantly improves work efficiency.

\*80g/m<sup>2</sup>

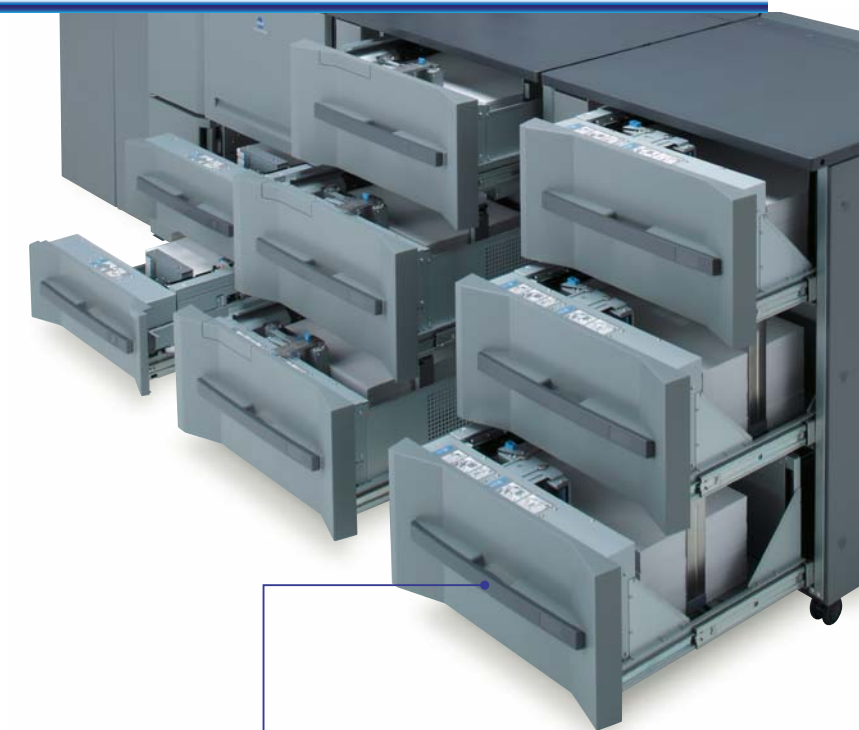

### Easy-access tray grip

All paper trays feature a universal design construction. The easy-to-grip handles allow more convenient opening for all users.

## Reliable design prevents paper mis-feeding and printing errors before they happen

### Air-suction paper feed mechanism

The optional PF-703 Paper Feed Unit utilises an air-suction paper feed unit that blows air from the sides and front. The paper then adheres to the conveyance belt by air suction. This reduces slipping caused by powder on the sheets, and ensures greater stability for high-speed output. The suction strength is automatically adjusted depending on paper type for optimised handling.

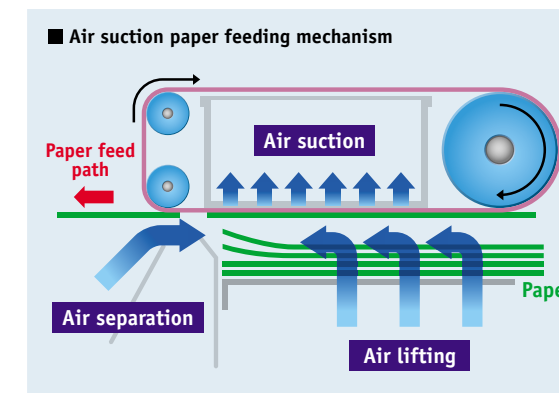

### Multi-sheet detection sensor

Attached to the paper feed unit in the main body, the ADF, the optional FD-503 Multi-fold Punch Unit and the optional FA-501 PI-PFU Unit are multi-sheet paper detection sensors that keep extra paper from being mixed in with printed materials. This ultrasound sensor detects sheets fed from all trays. When an extra sheet is found, printing is automatically suspended to prevent printing errors and speed troubleshooting.

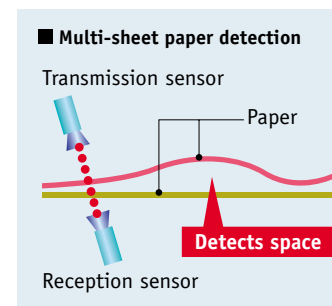

### Air-assist paper feed mechanism

The air-assist paper feed mechanism prevents coated paper from sticking while being fed. Air is sent to stacks of coated paper to facilitate paper handling and maintain stable feeding. The feature is included in all main unit trays, as well as the optional paper feed units.



## High Image Quality

**bizhub PRO 1200/1051 delivers monochrome output quality that rivals offset printing, producing consistent quality throughout high-volume jobs**



### Real 1,200dpi resolution

Documents can be copied at a high-quality resolution of up to 1,200x1,200dpi, resulting in sharp, crisp lettering and fine lines even at small font sizes, as well as smooth gradations and sharp details for images and photos. Additional smoothing processes during printing further enhance the appearance of your output.

### New Simitri HD Toner

Konica Minolta's new Simitri HD toner uses smaller, more consistently shaped particles, providing finer, straighter lines and more even halftones with fewer variations in density. Because it uses oil-less fixer, even solid blacks are produced with a natural looking gloss and reduced glare. The end result is beautiful image quality to rival that of offset printers.

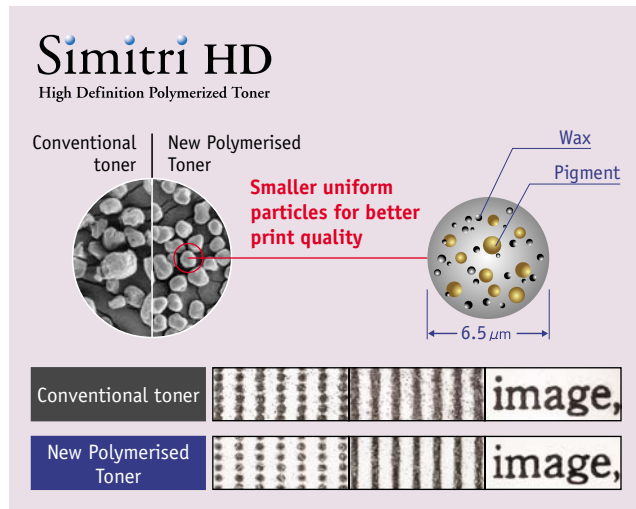

## Superior image stability ensures accurate, high-quality reproduction

### Improved D-Max

To achieve a greater image density, a new developer is being used and the developer settings have been improved. The electric charge between the drum and the developer sleeve has been strengthened, improving the developing quality. By raising the maximum image density (D-max) density fluctuations during large-scale printing have been minimised.

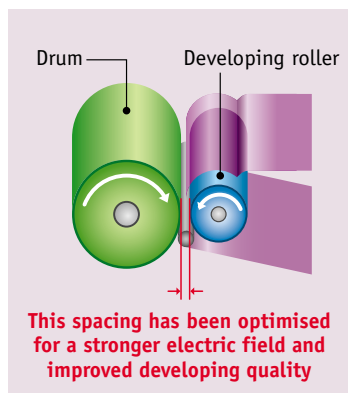

### New TCR and IDC sensors

The bizhub PRO 1200/1051 uses Image Density Control (IDC) sensor together with the newly developed Toner Carrier Ratio (TCR) sensor to better regulate image density. The TCR sensor controls toner density, while the IDC sensor controls the rotation speed of the developer sleeve. Compared to previous models, which only used the IDC sensor, this new arrangement achieves better prevention of toner spills and more consistent output quality. This means that wide variations in density will be reproduced consistently, even over long print runs.

### High coverage mode

This mode controls the image quality of high-coverage output during continuous printing, as this is when unevenness in density is most likely to occur. Output is monitored every 10 seconds or an average of 5 pages and if the output is judged to be a high-coverage document, print speed is automatically adjusted. This controls unevenness in density, ensuring documents maintain a high level of uniformity. You can choose between Image Quality Priority Mode or Speed Priority Mode depending on your needs.

Note: In High-coverage Mode, productivity is reduced to 30-40ppm.

### Improved developing unit agitation

To ensure print quality even at high output speeds, bizhub PRO 1200/1051 features improved developing unit agitation. The longer agitator screw and optimised rotation speed prevent fluctuations in toner density and ensure a consistent balance. This prevents changes in image density during continuous printing or at the ends of each output document.

## Advanced reproduction of fine text lines

### Belt transfer system

The bizhub PRO 1200/1051 uses a belt transfer system that improves the quality of paper feeding and images being transferred. Using an electric charge, the gap between the paper and the belt is eliminated. The pressure of the belt ensures that toner is fixed without unevenness for higher consistency. The incidence of image repellence at the paper's edge and nip resistance which can cause inaccurate transfers is also reduced.

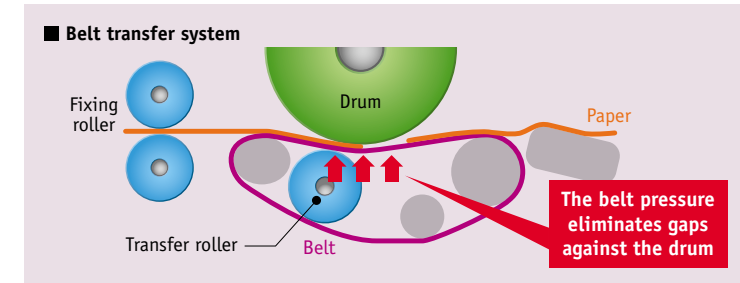

### LPH (LED Print Head) writing system

The new LPH system employs an LED print head with a beam diameter of only 30 microns, half the size of previous models, making resolutions of 1,200dpi possible. This enables even finer text quality and improved image gradations.

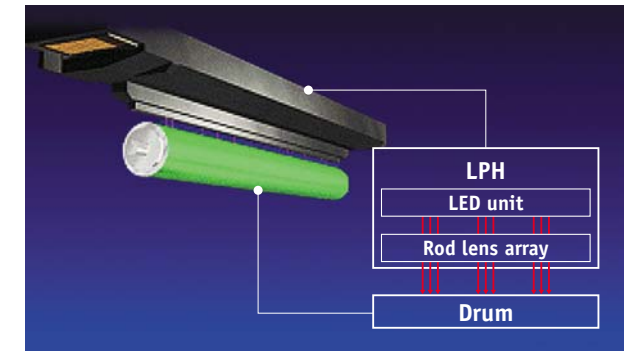

## Rich, lifelike gradations and halftone image processing

### Tone Curve Utility

The tone curve utility is a standard part of the print controller. This allows image brightness and contrast to be adjusted to prevent blow-out of white or collapse of blacks. No other software is required, making adjustments simple and fast.

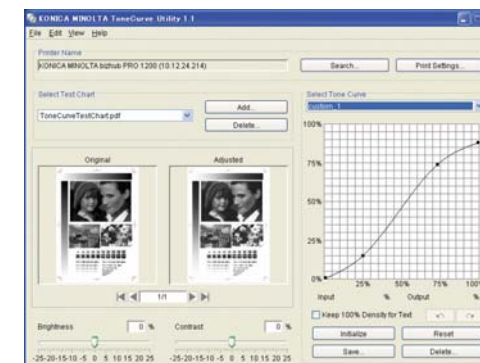

### CIE Colour Space

In cases where colour data is being used, CIE colour space conversion enables the most accurate reproduction in monochrome. This mode produces much richer shadows, detailed highlights and smooth gradations. \*This reduces output speed 10-20%

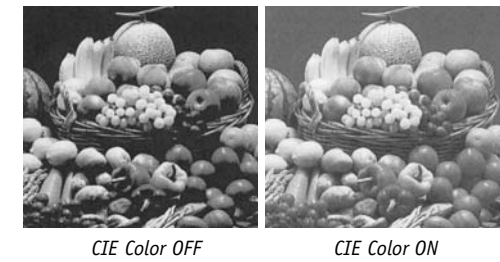

### Screen settings

New pre-setting screens (2 types in 3 patterns each) and dot screens were developed for 1,200dpi output, optimised for images, text or mixed data. By choosing the screen that best suits a particular output type, print quality can be maximised.

Screen settings		1,200dpi	600dpi
Pre-setting screens	Photo mode	Reproduces low-resolution images with smooth gradations	120 lpi / 86 lpi
	Photo/text mode	Suitable for photos and text	170 lpi / 106 lpi
	Text mode	Reproduces fine text lines clearly	212 lpi / 141 lpi
Dot screen	Reduces the possibility of moire patterns during overlay printing		

## High-quality double-sided printing

### Advanced image position precision

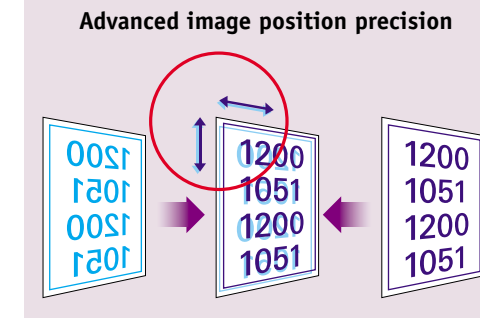

### Front and back registration

Using image shift and independent magnification adjustment, high-quality registration between front and back sides is possible. To eliminate small gaps between the two sides, minute adjustments to horizontal and vertical printing positions are automatically made. This level of accuracy is especially important in binding, where pages must be cut to fit together properly.

### Paper skew sensor

The paper skew sensor prevents gaps in output that can occur when a sheet of paper becomes momentarily stuck or warped. When the amount of bend in the sheet exceeds a pre-determined limit, printing automatically stops to prevent later output from being affected.

## In-line Finishing & Easy Operation

High-quality finishing capabilities allow a greater range of customer services to be offered, increasing profitability



## Versatile in-line finishing capabilities

### Multi-fold Punch Unit FD-503

6 folding styles available

The FD-503 Multi-fold Punch Unit provides an array of functions, including gate-fold, letter fold-in/out, double-parallel/Z-fold, sheet insertion and hole-punching. Two- and three-hole punching can be made along the side or top of each page on the left side of the page. This unit can also be used via manual insertion for off-line finishing.

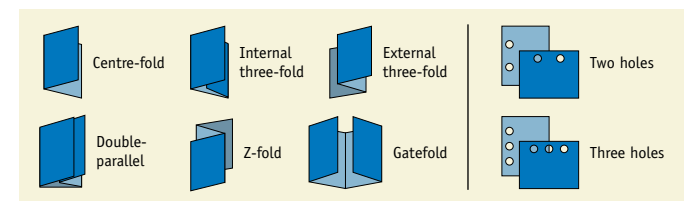

### PI-PFU Unit FA-501

Allows high-capacity sheet insertion

The FA-501 PI-PFU Unit can hold up to 5,000 sheets\* for insertion, and paper weights up to 350g/m<sup>2</sup>. This reduces the number of times the paper supply needs to be refilled when printing large orders. This allows cover sheets printed in colour to be created separately with an offset machine and then combined with monochrome documents for faster, smoother production.

\*80g/m<sup>2</sup>

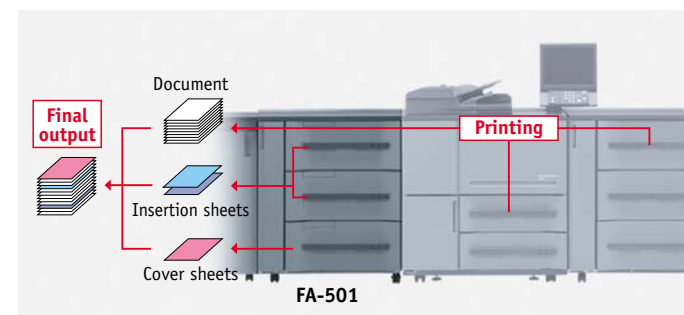

### Staple Finisher FS-521

Staple up to 100 sheets at once

By attaching the FS-521 Staple Finisher, up to 100 sheets can be stapled automatically, either by corner stapling or two-point stapling. The staple cutting and in-line clinch feature produce clean, attractive results even on small jobs. An improved stack alignment function ensures that sheets are never skewed or uneven.

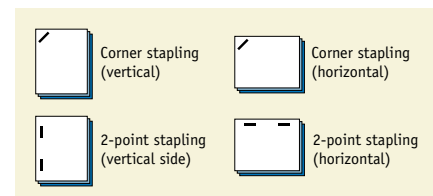

### Saddle Stitch Unit SD-506

Staple up to 50 sheets for 200-page booklets

The SD-506 Saddle Stitch Unit allows users to staple up to 50 sheets together, creating booklets of up to 200 pages. Saddle stitching also reduces paper displacement during binding and improves the strength and accuracy of two- and three-sheet folding. Double two-fold and three-fold functions and a face trimming function are also included. The automated fore-edge cutting function produces a clean finish while improving productivity.

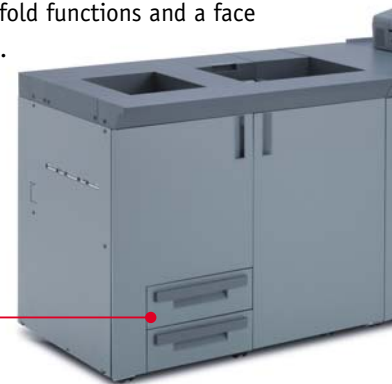

### Multi-hole Punch Unit GP-501\*

Inline hole punch unit for ring binding

Users can adjust the unit to produce holes specifically to fit 10 different styles of ring binder.

\*Not available in all countries. Please ask a sales person for details.

### Perfect Binder Unit PB-502/PB-503

Bind together up to 600 pages

The PB-502/PB-503 Perfect Binder Units allow users to bind up to 300 sheets, for up to 600-page books (30mm thick or less). The system allows fast and simple in-line cutting, gluing and binding, letting users offer improved services to their customers. The new PB-503 Perfect Binder Unit can be connected with the FS-521 Staple Finisher for better space- and cost-efficiency. A deodorising unit is also built into the perfect binder for greater workplace comfort.

### Cart

Finished documents from the PB-503 Perfect Binder Unit are automatically stacked on this cart for safe and convenient transport. Featuring smooth-rolling wheels and sturdy construction, it improves workplace efficiency and safety.



## Versatile, time-saving document management functions

### Flexible page layout function

For greater speed and convenience in preparing on-demand jobs, the bizhub PRO 1200/1051 automatically handles page imposition for a wide selection of arrangements, including saddle stitch, perfect binding and centre folding. In addition, This system is also ideal for printing of small-size repeat layouts, such as business cards, tickets and direct mail fliers. Imposition for up to 16 sides can be performed on the same sheet. This feature greatly simplifies the layout process, allowing users to complete jobs faster and more accurately.

### Page layout for binding

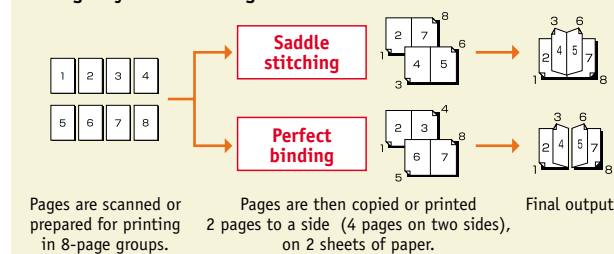

### Per-page function

This feature allows multiple printing and finishing settings to be applied to separate pages within a single document. For example, individual pages or sets of pages can be stapled, printed single- or double-sided, or printed on different types of paper. This gives customers much greater latitude in choosing how their documents will be produced, and the convenient interface makes it quick and simple for users to set.

### Per-page functions

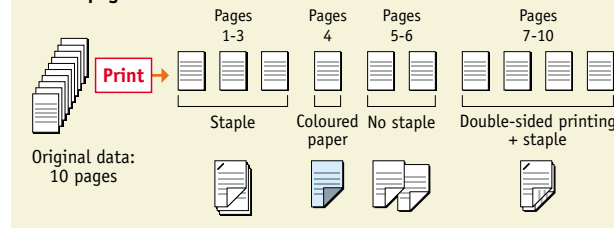

## Universal Design and ease-of-use features

### 15-inch colour LCD touch panel

The universal design of the touch panel consists of a large, intuitive 15-inch LCD monitor with 65,000 colours, displaying operation procedures in a direct, easy-to-understand format. The function buttons are all conveniently located along the top of the screen to improve visibility and operability. The interface is highly intuitive and customisable, allowing users to change the layout and text size, or create shortcuts of frequently used options, to best suit their needs. Furthermore, the screen display time is approximately 0.1 second, enabling a stress-free response.



### Universal Design

Universal design thinking has gone into every aspect of the bizhub PRO, to allow full functionality for all users. The paper trays all feature handles which can be gripped underhand or overhand. The output trays are dark gray for maximum contrast with paper for easier visibility. And the start button uses a blue LED that is visible even to users with red-green colour blindness. The bizhub PRO has also been certified by the Color Universal Design Organization (CUDO), in recognition of its ease of use regardless of colour vision ability.



3 axes of adjustment are possible, and can be set for maximum ease of use and visibility.

